

“VAVIS” 6 Touch Slider Panel with Socket Provision
Model : VTW/B-221M
Installation Manual

Installation Guidelines :

- ◆ The recommended concealed box to be used should be of 60mm depth.
- ◆ The concealed box must be fixed atleast 1 inch inside the wall surface.
- ◆ All the load wires connected to the panels must not be more than 6 inch long.
- ◆ Avoid over tightening of the mounting screws in the concealed box.
- ◆ The VAVIS Panel back box should not get bend due to over tightening of screws.
- ◆ Ensure that the wall surface is plain and in level on which the VAVIS back box is to be fixed. If it is un-even, the back box will get bend while tightening the screws and there may be chances of loose connection.
- ◆ After connecting all the loads and back box on the concealed box, fix the VAVIS Glass Panel properly and ensure that it is perfectly locked with the back box.
- ◆ Never use CAT5/6 Cable for any load or looping the power in the back box. This may result into improper functioning of VAVIS Panels.
- ◆ Any VAVIS Panel damaged due to improper connections, installation by non technical person or improper power supply will not be covered under warranty.

Technical Specifications :

Operating Voltage	: 90 to 270 VAC
Operating Temp	: 0 to 55°C
Frequency	: 50 - 60 Hz
On/Off	: 2 x 800W Max.
Fan/Dimmer	: 2 (Triac) x 200W Max.
Curtain	: 1 x 800W Max.
Power Consumption	: < 10mW
Mounting Box	: 6 Module (75x208x60 mm approx.)

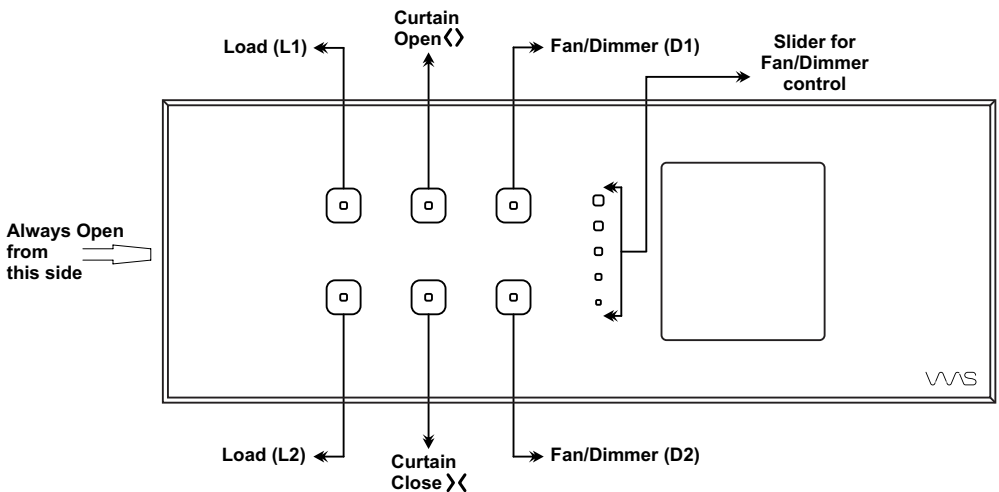

To control the Fan/Dimmer, select the respective Fan/Dimmer Touch button and slide the finger on the slider upward direction to increase the level and downward direction to decrease the level of Fan/Dimmer. To switch off the Fan/Dimmer, touch and hold the respective touch button for 3 secs.

Mechanical Accessories compatible is Crabtree Athena Series, 1 and 2 module size

Wiring Diagram Mains Supply

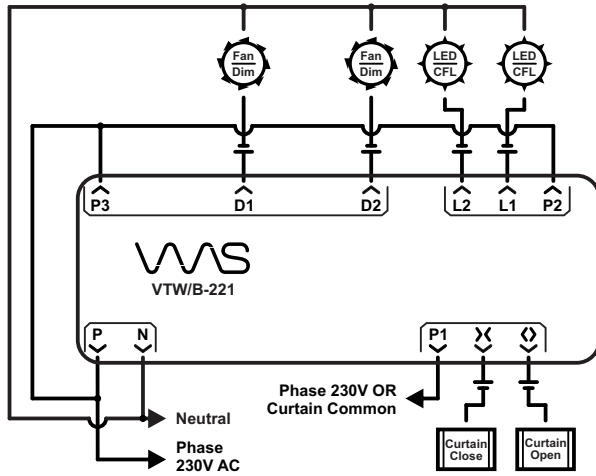

Note : P1 to be connected to 230V Phase for AC Motor Curtain
OR to be connected to Common of Curtain Motor for Pulse Type

Wiring Diagram Backup Supply

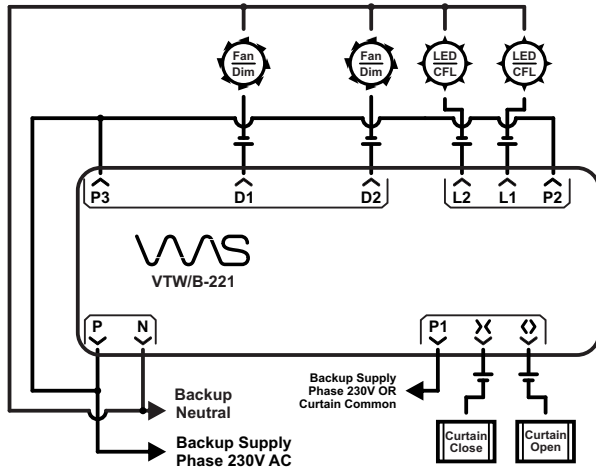

Note : P1 to be connected to Backup Supply Phase for AC Motor Curtain OR to be connected to Common of Curtain Motor for Pulse Type. In case of Mains Supply failure, all Loads and Curtain will work on Backup Supply

**Cutout Dimensions (mm) for
Mounting on Wooden surface**

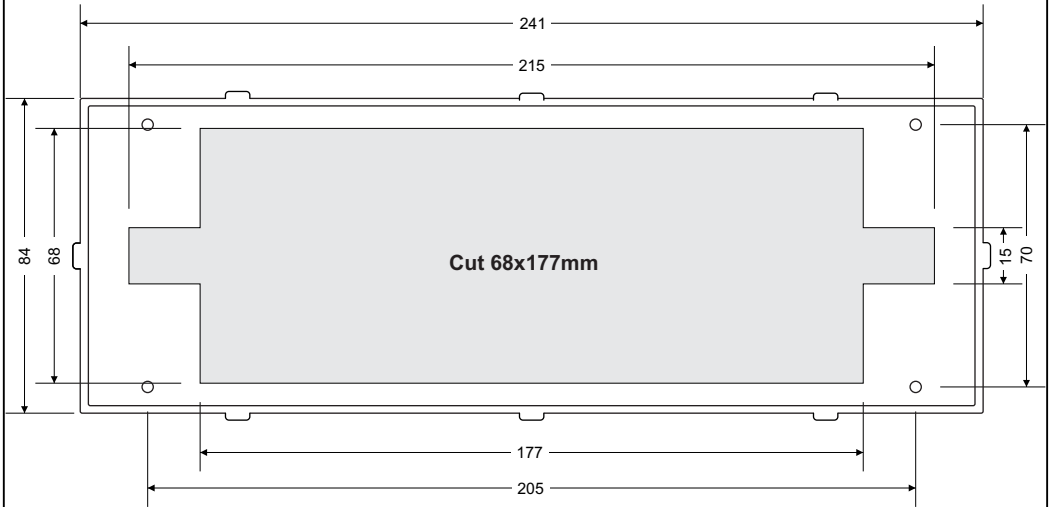

Back Box Size : 84x241mm

WARRANTY

VAVIS Products are warranted against all manufacturing defects for a period of 12 months from the date of purchase (In case of any complaints please contact your dealer). Warranty is not applicable to rubber / plastic parts, glass, chipping / peeling of paint, coating, breakage and any other damage due to transportation, mishandling & negligence, normal wear and tear and tampering by unauthorised person or in case the serial number is altered / defaced or tampered with, other conditions subject to the above, the unit should be brought to the nearest Dealer or our Works at your cost along with the Warranty Card issued by the dealer with his seal and signature.

**LIABILITY FOR CONSEQUENTIAL LOSS OR DAMAGE IS NEITHER ACCEPTED NOR IMPLIED.
LIMITED WARRANTY**

Seller does not represent that the product may not be compromised or circumvented; that the product will prevent any personal injury or property loss, fire or otherwise; or that the product will in all cases provide adequate warning or protection. Buyer understands that a properly installed and maintained may only reduce the risk of fire or other events occurring, but it is not insurance or a guarantee that such will not occur or that there will be no personal injury or property loss as a result.

Consequently, Seller shall have no liability for any personal injury, property damage or other loss based on a claim the product failed. However, if Seller is held liable, whether directly or indirectly, for any loss or damage arising under this limited warranty or otherwise, regardless of cause or origin, Seller's maximum liability shall not in any case exceed the purchase price of the product, while shall be the complete and exclusive remedy against Seller.

We reserve the rights to modify " The Design & Specifications " of the products without prior notice.

Manufactured By :

For support contact :

+91 81289 86936



Gujarat, India